

# electriciQ

## USER MANUAL



### **Light Panel Far Infrared Carbon Heater with Smart App ECFIRPH7W**

Thank you for choosing electriciQ  
Please read the manual before using this heater  
and keep it safe for future reference.  
Visit our page [www.electriQ.co.uk](http://www.electriQ.co.uk) for our entire product range

## **CONTENTS**

|                          |    |
|--------------------------|----|
| SAFETY INSTRUCTIONS      | 3  |
| PRODUCT OVERVIEW         | 6  |
| INSTALLATION             | 5  |
| OPERATION                | 7  |
| SETTING UP THE APP       | 8  |
| USING THE APP            | 13 |
| CLEANING AND MAINTENANCE | 19 |
| TROUBLESHOOTING          | 19 |
| TECHNICAL SPECIFICATIONS | 20 |
| SUPPORT                  | 20 |
| PRODUCT FICHE            | 21 |

## **SAFETY INSTRUCTIONS**

### **IMPORTANT**

- Carefully read the instructions before operating the unit
- This appliance is for indoor use only.
- Rating: This unit must be only connected to a 220-240 V / 50 Hz earthed outlet.
- Installation must be in accordance with the regulations of the country where the unit is used.
- If you are in any doubt about the suitability of your electrical supply have it checked and, if necessary, modified by a qualified electrician.
- This heater has been tested and is safe to use. However, as with any electrical appliance - use it with care.
- Disconnect the power from the unit before dismantling, assembling or cleaning.
- Avoid touching any moving parts within the appliance.
- Never insert fingers, pencils or any other objects through the guard.
- This appliance can be used by Children aged from 8 years and above and persons with reduced physical, sensory or mental capabilities or lack of experience and knowledge if they have been given supervision or instruction concerning use of the appliance in a safe way and understand the hazards involved. Children shall not play with the appliance. Cleaning and user maintenance shall not be carried out by children.
- Children aged from 3 years and less than 8 years shall only switch on/off the appliance provided that it has been placed or installed in its intended normal operating position and they have been given supervision or instruction concerning use of the appliance in a safe way and understand the hazards involved. Children aged from 3 years and less than 8 years shall not plug in, regulate, or clean the appliance or perform user maintenance.
- Children under 3 years should be kept away unless continuously supervised.
- Some parts of this product can become very hot and cause burns. Particular attention has to be given where children and vulnerable people are present.
- Do not clean the unit by spraying it or immersing it in water.
- Never connect the unit to an electrical outlet using an extension cord. If an outlet is not available, one should be installed by a qualified electrician.
- Never operate this appliance if the unit, cord or plug is damaged. Ensure the power cord is not stretched, exposed to sharp object/edges, or routed under the unit.
- Any service other than regular cleaning should be performed by an authorised service representative. Failure to comply could result in a voided warranty.
- Never use the plug as a switch to start and turn off the heater. Use the provided power switch on the rear of the unit.
- Do not use an external timer.
- Do not cover the air inlet or outlet, or place items close to the unit which may

restrict airflow, as this may present a fire risk.

- The heater must not be located immediately below a socket outlet.
- Always ensure the unit is secure before operation. Do not use on unstable or uneven surfaces and if wall-mounted, it must be securely attached to a suitable wall.
- Do not move or tilt the unit.
- Avoid keeping the unit in direct sunlight for a long period of time.
- The heater is designed to be used at temperatures above -20°C. If it is exposed to temperatures below this, it must be allowed to warm above this level before operation.
- Do not attempt to repair, disassemble or modify the appliance. This unit contains no user-serviceable parts.
- Always unplug or disconnect the appliance from the mains power supply when not in use, or when moving or cleaning it. Do not pull the cord to unplug the heater.
- Keep the heater clean. Do not allow any object to enter the ventilation or exhaust opening as this may cause electric shock, fire, or damage to the heater.
- Do not use the appliance for anything other than its intended use. It is designed for domestic indoor use only.
- There may be a trace of odour during the first few minutes of initial use, or after a period of storage. This is normal and will quickly disappear.
- This appliance has hot and arcing or sparking parts inside. Do not use it in areas where gasoline, paint, or any flammable liquids are used or stored.
- This appliance is not intended for use in bathrooms, laundry areas and similar humid locations. Never locate this appliance where it may fall into a bathtub or otherwise become exposed to water.
- If the unit is wall-mounted, it must be installed in accordance with current regulations for the area of installation. If unsure, professional advice should be sought.
- **WARNING:** To reduce the risk of fire or electrical shock, DO NOT use this appliance with any solid-state Speed Control Device or any variable speed controllers.

### **ENERGY SAVING AND UNIT SAFETY PROTECTION TIP**

- Do not cover or restrict the airflow. Do not use in a dusty environment.
- For safety and maximum performance, when used as a portable unit the minimum distance from a wall or objects should be 50cm.

# WALL MOUNTING INSTRUCTIONS

**NOTE:** This heater is designed to be mounted vertically on a solid wall. If the unit does not feel secure when fixed, you will need appropriate fixings for the wall (not supplied). Please make sure the wall is safe to mount. We highly recommend to have the panel installed by a qualified electrician or installer. The distance from the heater to the floor must be at least 20 cm.

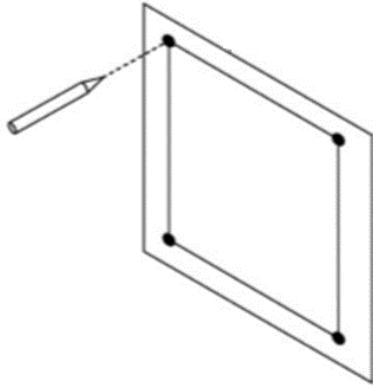

Step 1. Use the supplied template to mark the position of the holes on the wall.

Step 2. Drill holes using an 8mm drill bit.

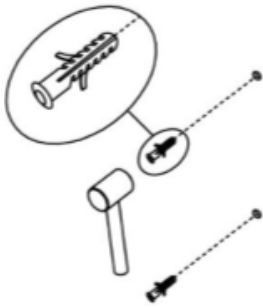
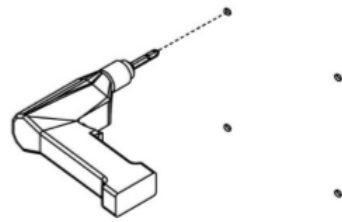

Step 3. Insert the wall plugs into the holes.

Step 4. Screw in the supplied screws to the wall.

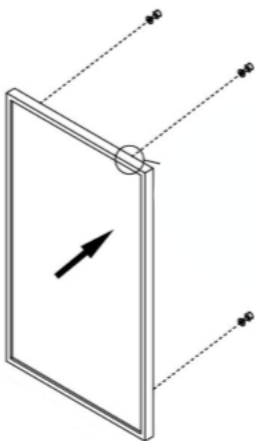
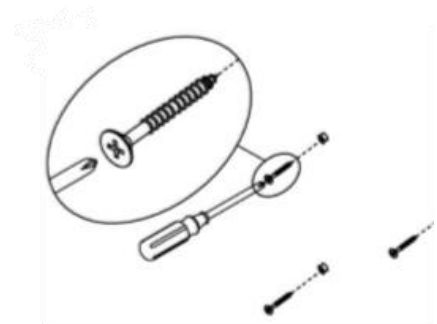

Step 5. Mount the panel on the screws.

Step 6. Move the panel to the left and then down until it's secured.



## OPERATION

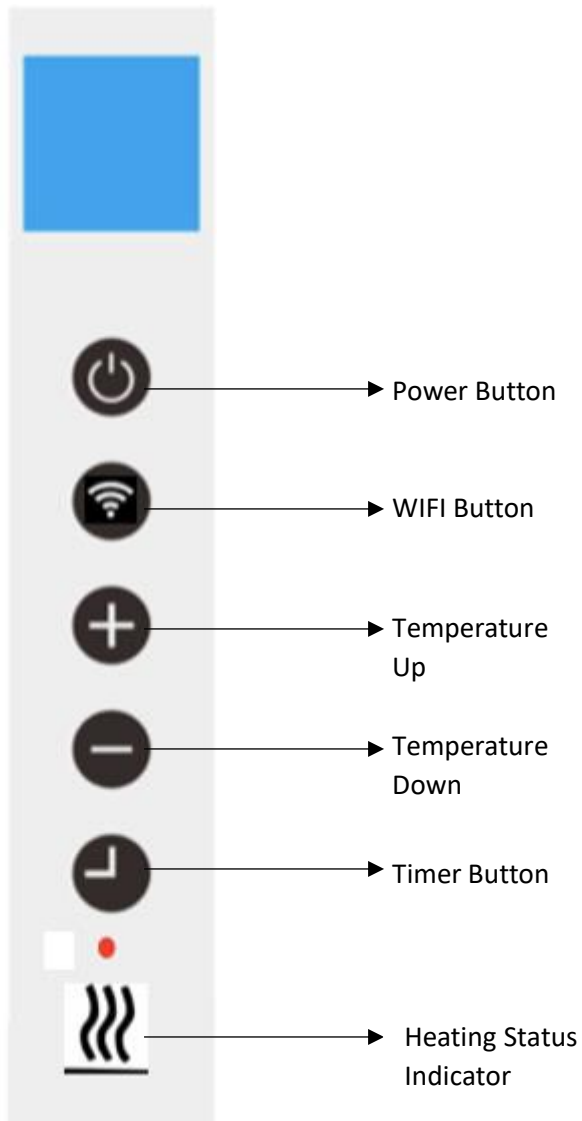

|                         |   |
|-------------------------|---|
| <b>Power</b>            | Turns the unit On or Off                            |
| <b>WIFI</b>             | Use to change the WIFI mode                         |
| <b>Temperature Up</b>   | Used to increase the desired temperature            |
| <b>Temperature Down</b> | Used to decrease the desired temperature            |
| <b>Timer Button</b>     | Used to set a countdown timer and to disable WIFI   |
| <b>Heating Status</b>   | Indicates whether the heater is currently operating |

## DISPLAY

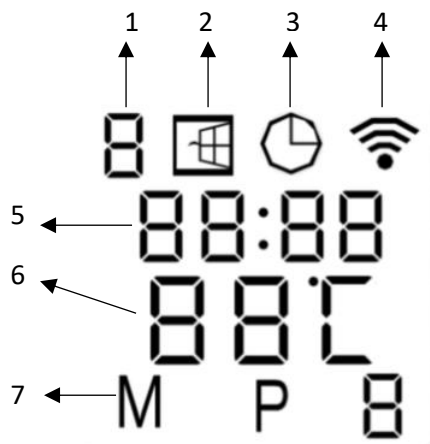

|          |                       |
|----------|-----------------------|
| <b>1</b> | Weekday               |
| <b>2</b> | Open Window Indicator |
| <b>3</b> | Timer Indicator       |
| <b>4</b> | WIFI Indicator        |
| <b>5</b> | Time                  |
| <b>6</b> | Temperature           |
| <b>7</b> | Modes                 |

## **OPERATION**

### **MANUAL CONTROL**

Adjust your desired room temperature using the “-” and “+” buttons, after 2 seconds the updated desired temperature will be set.

### **TEMPERATURE CALIBRATION**

If you find that the temperature display is not showing an accurate reflection of the room temperature, it can be adjusted. Press and hold the “-” button for 5 seconds to enter temperature calibration. The amount the temperature is changed by can be adjusted using the “-” or “+” buttons (Range: -5 to 5°C)

### **TIMER**

The inbuilt timer will allow you to set the unit to turn off after a set period of time. Please note this timer is a one-use timer, and starts operation when programmed.

1. While the unit is operating, press the TIMER button to activate the timer.
2. Use the Temperature + and – buttons to adjust its duration.
3. Once the set time has elapsed, the unit will turn off automatically.

Press the POWER button before the time has elapsed, the timer will be cancelled and the unit will turn off.

### **OPEN WINDOW DETECTION**

This heater is equipped with an open window detection function. If the room temperature decreases dramatically in a short period of time it will recognize that a window is open. The window sign on the screen will start to flash and the heater will enter standby for 30 minutes. You can deactivate and activate this function holding the Timer button for 5 seconds, and the open window sign on the screen will disappear.

## CONNECTING THE APPLIANCE TO WIFI

### DOWNLOAD THE APP TO YOUR PHONE

Download the "TUYA SMART" app, from your chosen app store, using the QR codes below, or by searching for the app in your chosen store.



**Android**



**IOS**

### MODES AVAILABLE FOR SETUP

The heater has two different setup modes, Quick Connection and AP (Access Point). The quick connection is a quick and simple way to set the unit up. The AP connection uses a direct local WiFi connection between your phone and the heater to upload the network details.

By default, WiFi is enabled when you switch the heater on. The WiFi symbol will flash until a connection is established. To turn the WiFi off, press and hold the WiFi button for 10 seconds until the heater beeps. The WiFi symbol will flash quickly to indicate the unit is in quick connection mode

Please ensure your device is in the correct WiFi connection mode for the connection type you are attempting, the flashing WiFi indicator on your heater will indicate this.

| <b>Connection Type</b> | <b>Frequency of Flashes</b> |
|------------------------|-----------------------------|
| Quick Connection       | Flashes twice per second    |
| AP (Access Point)      | Flashes once per second     |

### CHANGING BETWEEN CONNECTION TYPES

To change between the Wifi connection modes press the WiFi button.



# REGISTER THE APP

1. Press on the register button at the bottom of the screen.

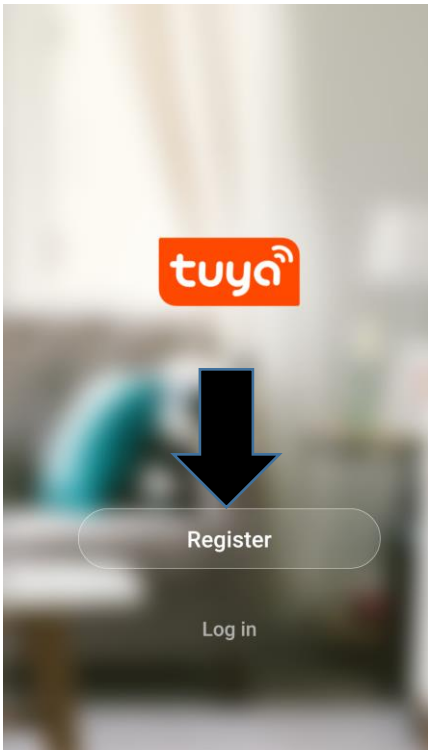

2. Read the Privacy policy and press the Agree Button.

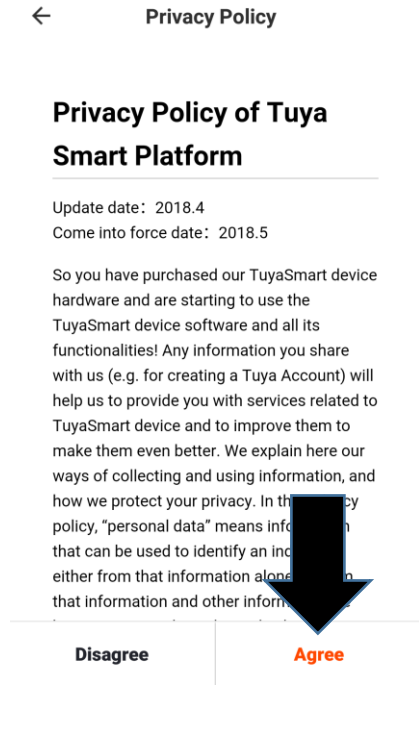

3. Enter your email address or phone number and press continue to register.

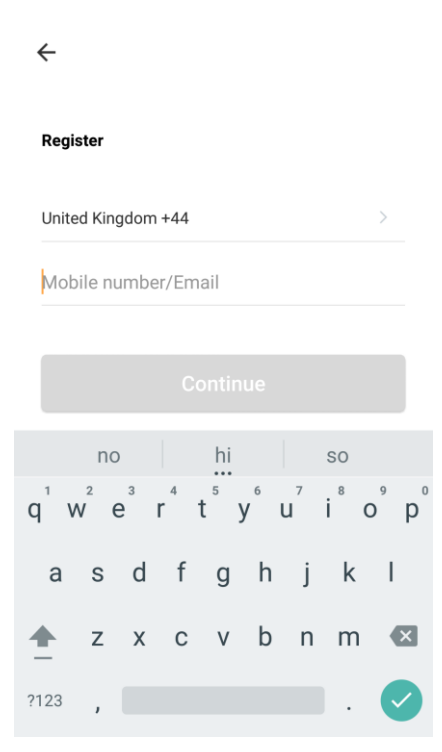

4. A verification code will be sent by the method selected in step 3. Enter the code into the app.

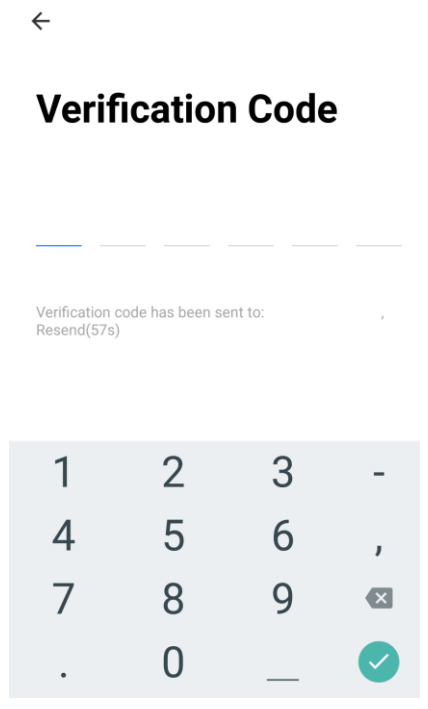

5. Type in the password you would like to create. This needs to be 6-20 characters, with letters and numbers.

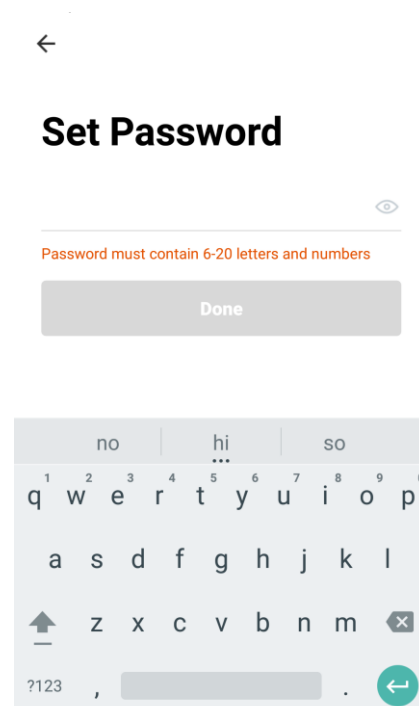

2. The app is now registered. It will automatically log you in following registration.

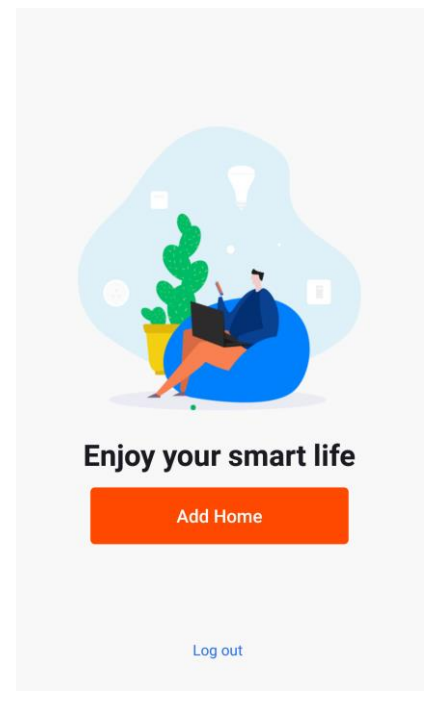

## SETTING UP YOUR HOME WITHIN THE APP

TUYA is designed so it can work with a large number of compatible smart devices within your home. It can also be set up to work with multiple devices within different houses as such during the setup process, the app requires that different areas are created and named to allow easy management of all your devices. When new devices are added, they are assigned to one of the rooms you have created.

### CREATING ROOMS

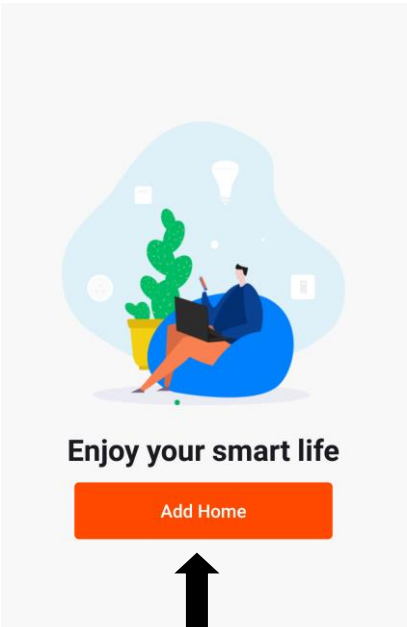
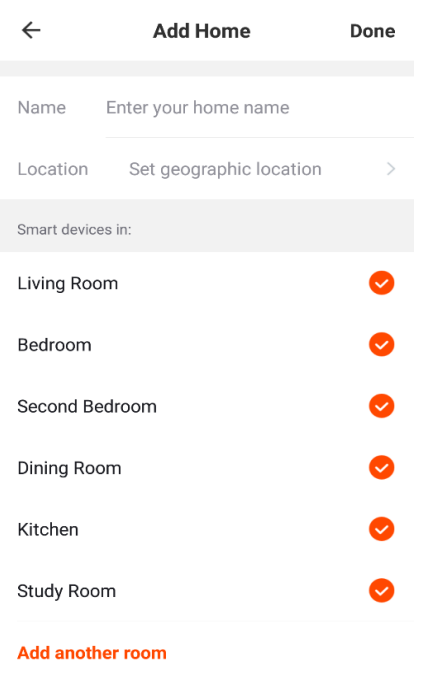
|  |   |  |
|--|---|--|
| <p>1. Press on the ADD HOME button.</p>  | <p>3. Type in a name for your home,<br/>4. Press on the location button to select the location of your home. (See <b>SETTING YOUR LOCATION</b> below)<br/>5. New rooms can be added by pressing the <b>ADD ANOTHER ROOM</b> option at the bottom. (See <b>ADD ANOTHER ROOM</b> below)<br/>6. Untick any rooms that are not required on the app.<br/>7. Press <b>DONE</b> in the top right corner.</p> |  |
|--|---|--|

### SETTING YOUR LOCATION

Use your finger to move the orange HOME symbol.

When the symbol is in the approximate location of your home, press the confirm button in the top right corner.

Location details allows the app to be set up later to respond to weather conditions in your area.

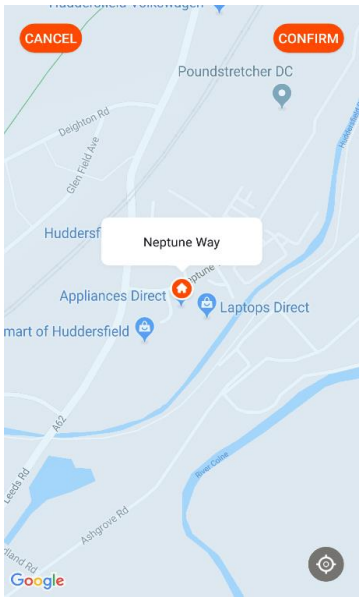

### ADD ANOTHER ROOM

Type in the name of the room, and press Done in the top right corner

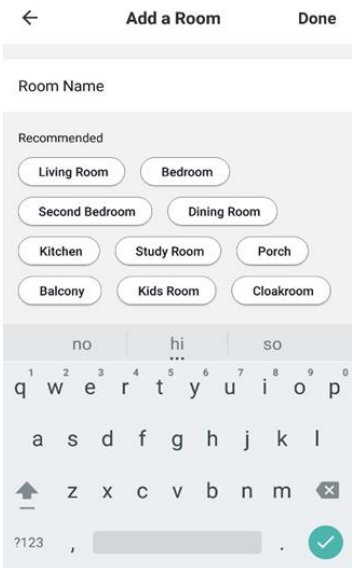

## CONNECTING USING THE QUICK CONNECTION METHOD

Before initiating the connection, make sure the WiFi indicator is flashing twice per second. If not follow the instructions for changing the connection mode. Also ensure your phone is connected to the WiFi network. (We advise turning mobile data off during setup)

1. Open app and press “+” to add device, or use the add device button

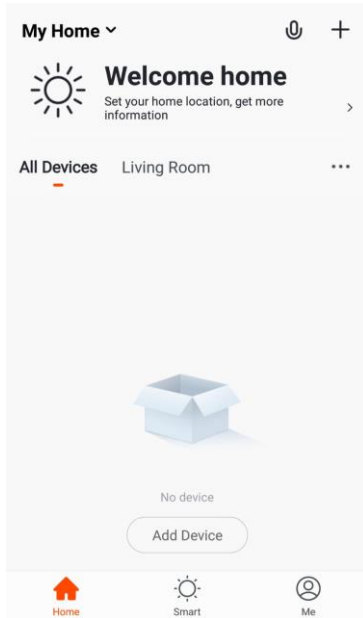

2. Select the type of device as “Heater” within the Home Appliance tab.

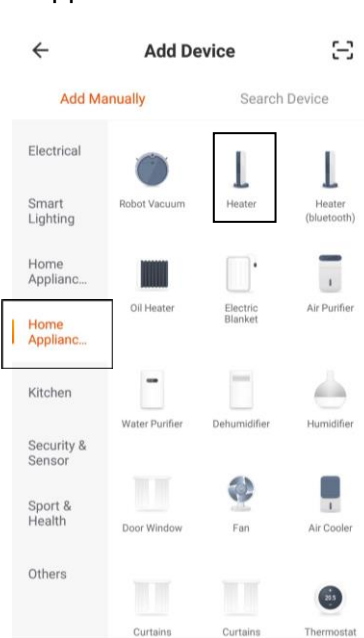

3. Press on the orange button at the bottom of the screen.

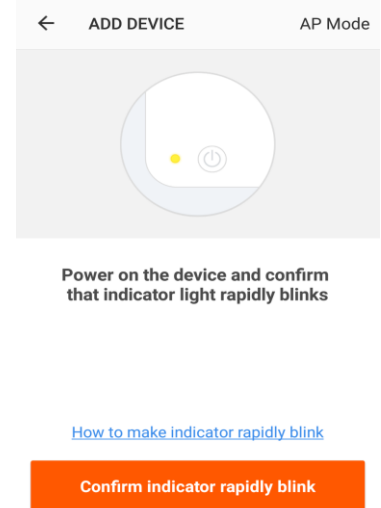

4. Enter your Wi-Fi password and press confirm.

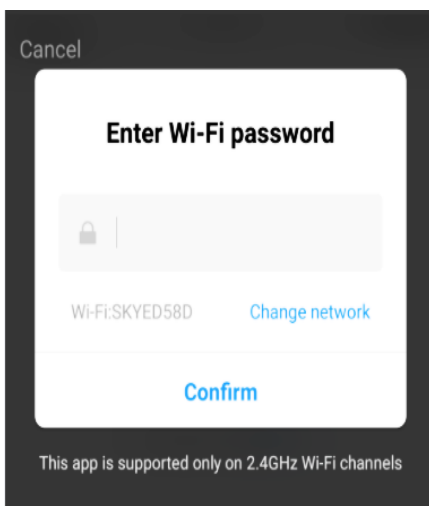

5. This will then transfer the settings to the heater. Wait for this to complete. If this fails, retry.

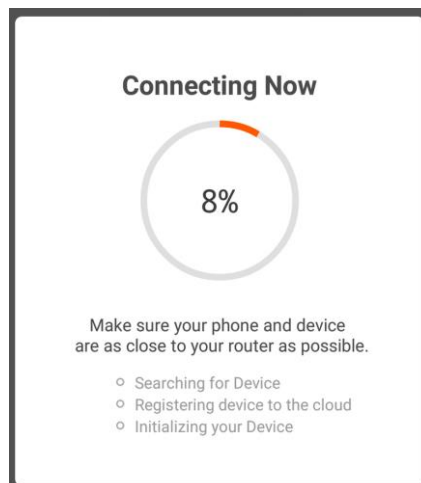

## CONNECTING USING AP MODE (ALTERNATIVE METHOD)

Before initiating the connection, make sure the unit is in standby mode, with the WiFi Indicator flashing once per second. If not follow the instructions for changing the WiFi connection mode. Also ensure your phone is connected to the WiFi network. (We advise turning mobile data off during setup)

1. Open app and press “+” to add device, or use the add device button

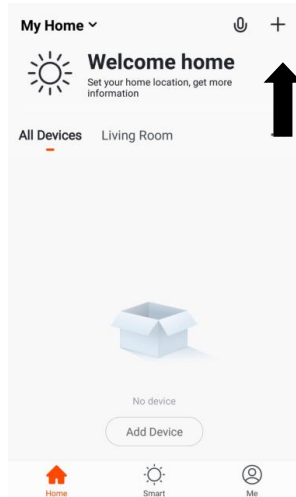

2. Select the type of device as “Heater” within the Home Appliance tab.

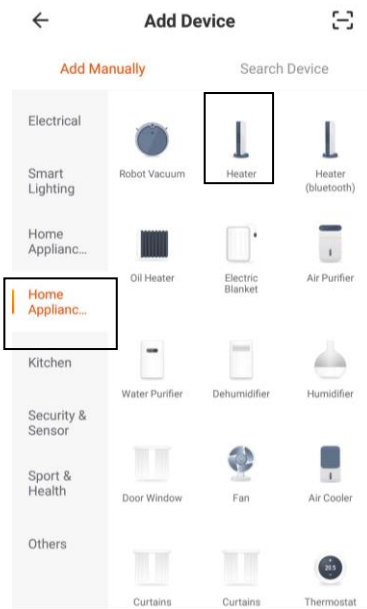

3. Press on the AP mode button in the top right of the screen.

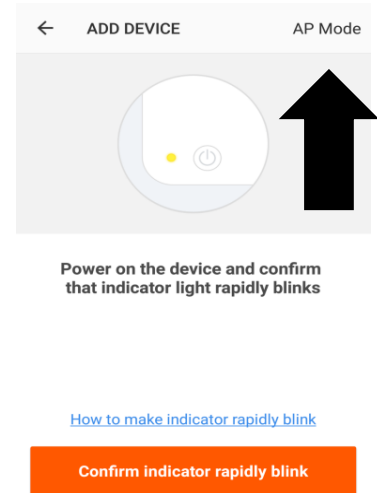

4. Ensure the WiFi indicator on the heater is slowly flashing (once per second), then press on the orange button at the bottom of the screen to confirm

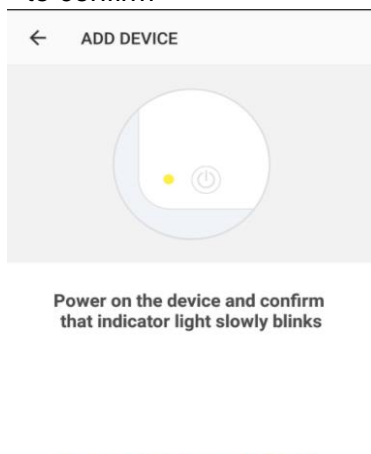

5. Enter your WiFi password and press confirm.

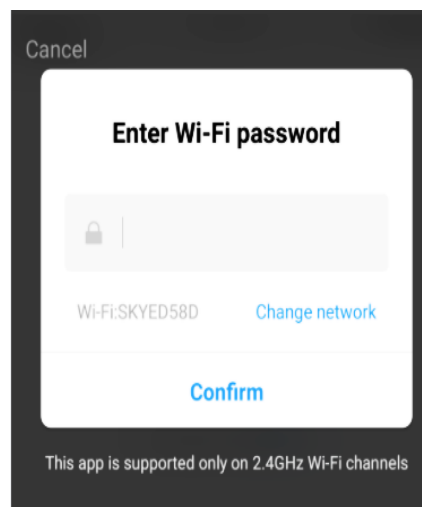

6. Go to network settings in your phone and connect to the “SmartLife xxx” connection. There is no password to enter. Then return back to the app to complete setup.

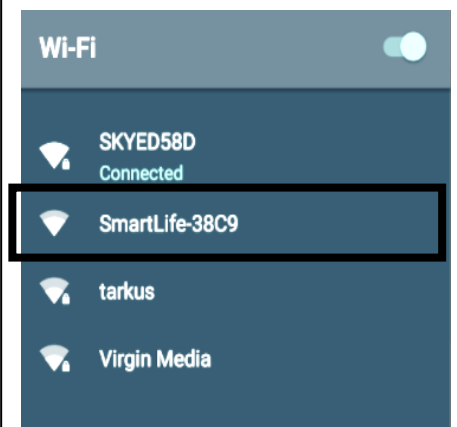

This will then transfer the settings to the heater.

Once the connection process has completed, go back to the network settings on your phone to ensure your phone has reconnected to your WiFi router.

# CONTROLLING YOUR APPLIANCE THROUGH THE APP

## THE HOME SCREEN

**NOTE:** Due to continuous development of the app, the layout and available features may be subject to change.

Each device has its own entry on the home screen to allow the user to either quickly turn the unit on or off, or to enter the device screen to make other changes.

**Voice Control:** Press to give verbal instructions for operation.

**Add Device:** Add a device to the app, and go through the setup process.

**Name of Heater:** Press to enter the Device Screen

**Home:** Return to home screen from the Smart Scene and Profile screens

**Smart Scene:** Allows you to program intelligent behaviour based on the internal and external environment

**Profile:** Provides the option for changing settings,

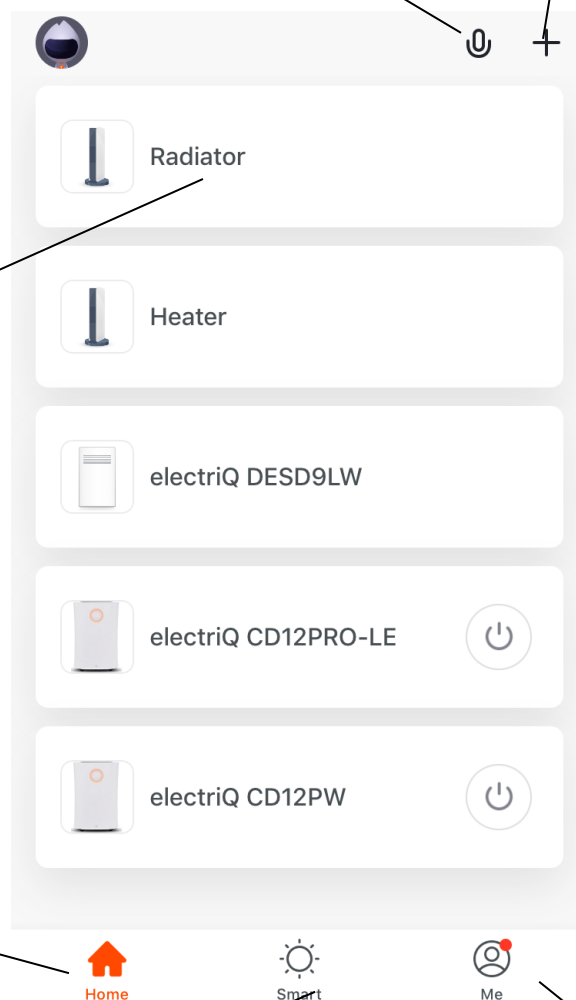

## DEVICE SCREEN

The device screen is the main control screen for the heater, providing access to the controls to amend the functions and settings.

**Back:** Returns to the Home Screen

**Device Name**

**Edit Name:** Use to change the name of the heater

**Desired Temperature:**  
Displays what has been set as the target room temperature.

**Current Temperature:**  
Displays what the current temperature is.

**Decrease Desired Temperature**  
Temperature range 15-35C

**Increase Desired Temperature**  
Temperature range 15-35C

**Power:** Use to turn the unit on or off.



Switch



Countdown



Schedule

### Countdown Timer:

Use to set a timer to turn the unit on or off.

### Schedule:

Use to program the heater to change the operation and desired temperature throughout the week.

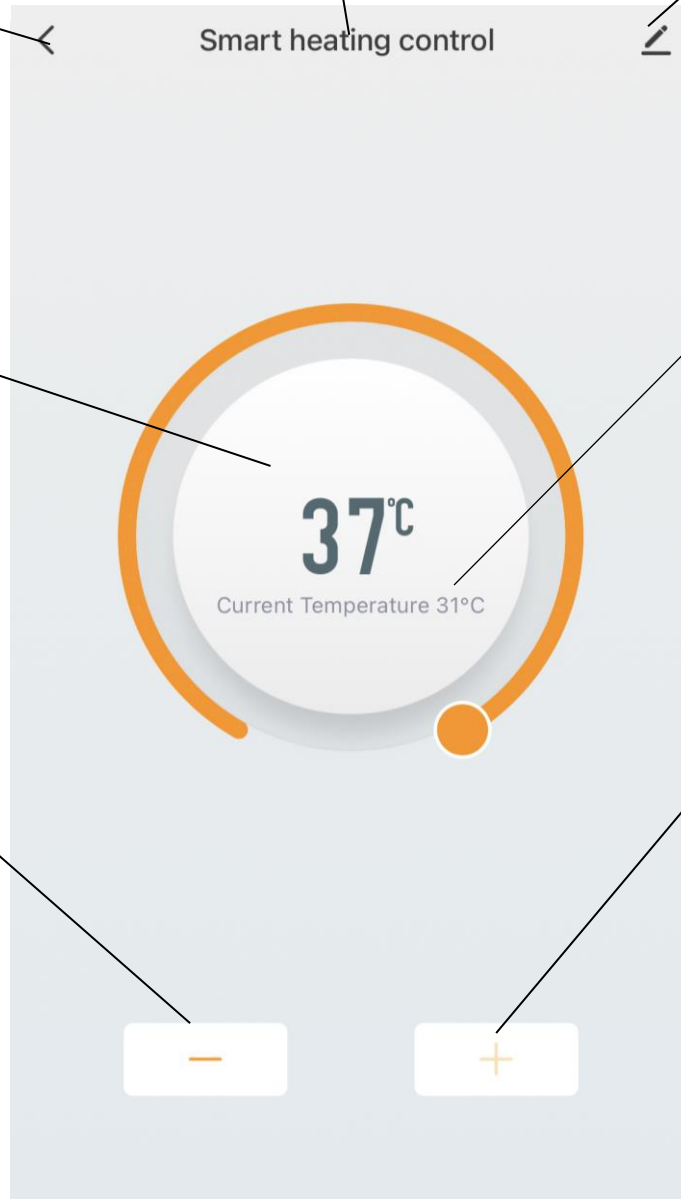

## SCHEDULE

The app provides a timer that can be easily programmed using your phone. This can be accessed through the schedule option at the bottom of the device screen.

A number of separate schedule entries can be created to automate operation of the heater throughout the week. All currently created schedules will be visible on this screen, with the option to add a new schedule.

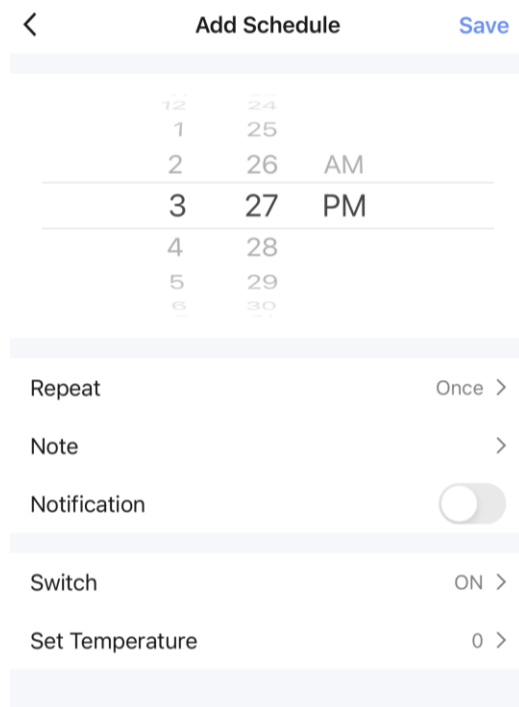
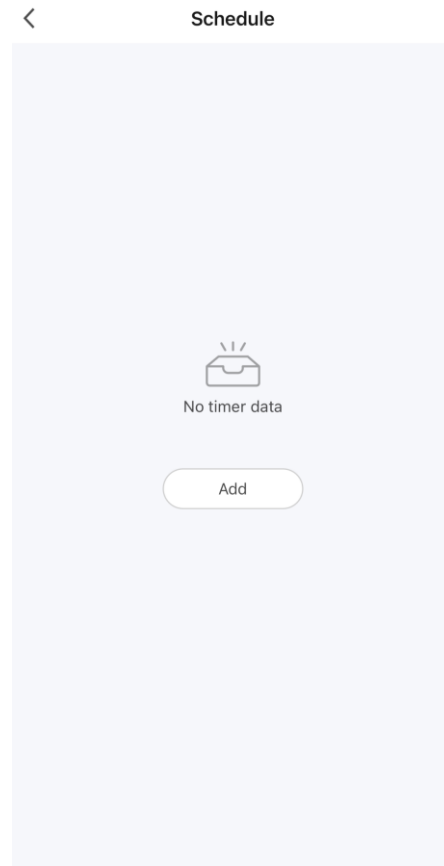

Select the time you want the action to occur, how often you want it to occur, and whether the unit is to turn on or off, and the desired temperature.

Press on save in the top right corner, and the schedule is activated, and will be visible on the main schedule screen. Schedules can also be amended and deleted as required.

# SMART SCENES

Smart Scenes is a powerful tool providing the option to customize the operation of the air heater based both on conditions within the room and outside influences. This gives the user the option of specifying much more intelligent actions. These are split into two categories Scene and Automation.

## SCENE

Scene allows for a one touch button to be added to the Home Screen. The button can be used to change a number of settings in one go, and can change all the settings within the unit. A number of scenes can easily be setup, allowing the user to easily change between a number of preset configurations.

Below is an example of how to set up a scene:

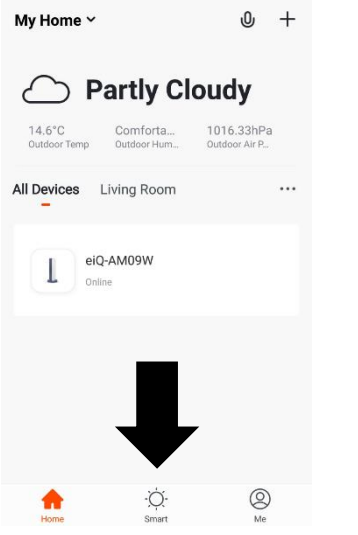
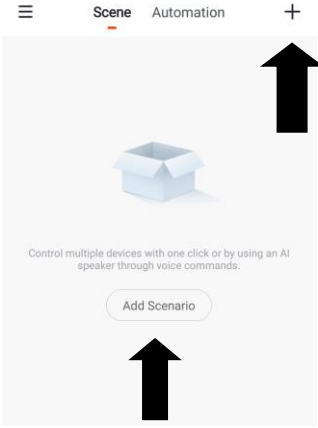
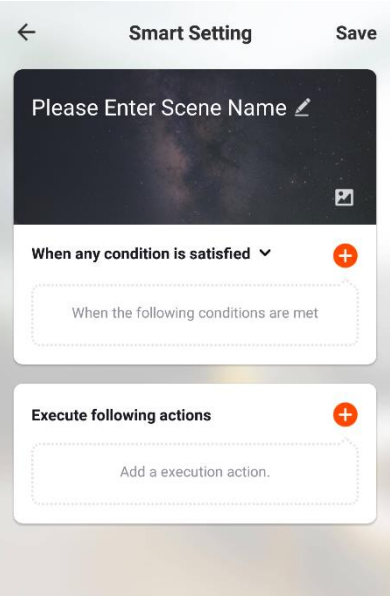
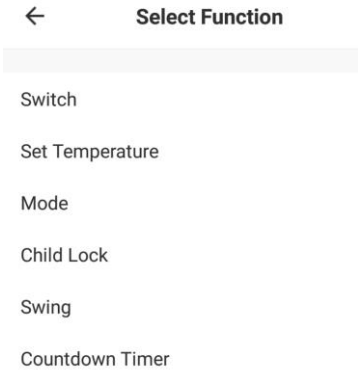
|   |   |
|---|---|
| <p>1. Press on the Smart tab at the bottom of the Home screen</p>   | <p>2. Press on the Plus in the top right corner or on Add Scenario to add a smart scene.</p>   |
| <p>3. Press the Pen next to "Please Enter Scene Name" to input the name for your Scene</p> <p>Show on Dashboard: Leave this on if you require the scene to be displayed as a button on the Home Screen</p> <p>Press the Red Plus to add the action required. Then select the heater from the list of devices.</p>  | <p>4. Chose the function, set the value for the function, and then press the back button in the top right corner, to return to the previous screen.</p>  |
| <p>6. Once all the functions required have been added, press the Save button in the top right corner to finalize and save your new Scene. It will then be saved to the home screen</p>  |   |



# AUTOMATION

Automation allows an automatic action to be set up for the device. This can be triggered by the Time, and a range of other influences, depending what other TUYA enabled devices you have on the network.

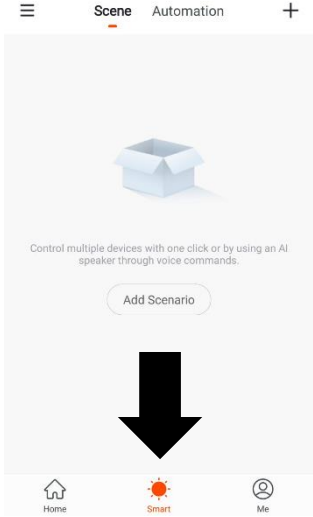
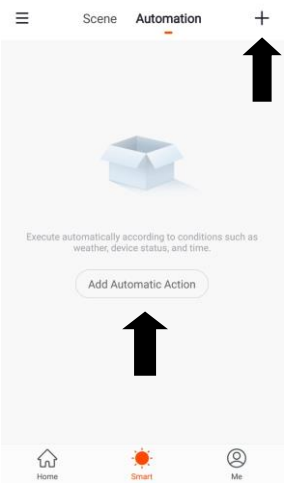
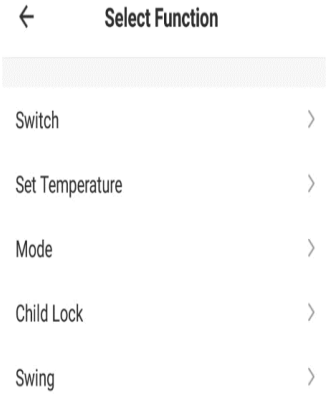
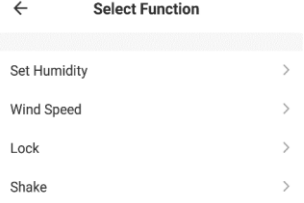
|   |   |  |
|---|---|--|
| <p>1. Press on the Scene tab at the bottom of the Home screen</p>    | <p>2. Press on the Automation tab at the top of the screen.</p>    | <p>3. Press on the + at the top of the screen or press on Add Automatic Action</p>  |
|    | <p>4. Setup is very similar to the scene setup on the previous page, and includes an extra section for specifying a trigger for the scene to start.</p> <p>Press the Pen next to “Please Enter Scene Name” to input the name for your Scene</p> <p>Press the Red Plus next to “When any condition is satisfied” to add the trigger</p> <p>Press the Red Plus next to “Execute following actions” to add the action required. Then select the heater from the list of devices.</p> |   |
| <p>6. Chose the function, set the value for the function, and then press the back button in the top right corner, to return to the previous screen.</p>  | <p>7. Once all the functions required have been added, press the Save button in the top right corner to finalize and save your new scene.</p> <p>The automation is now set up, it can be turned on and off using the toggle on the home page.</p>   |  |



Click here to set ni... >



### PROFILE TAB

The profile tab gives you the option to edit both your detail, and use the added features of the unit.

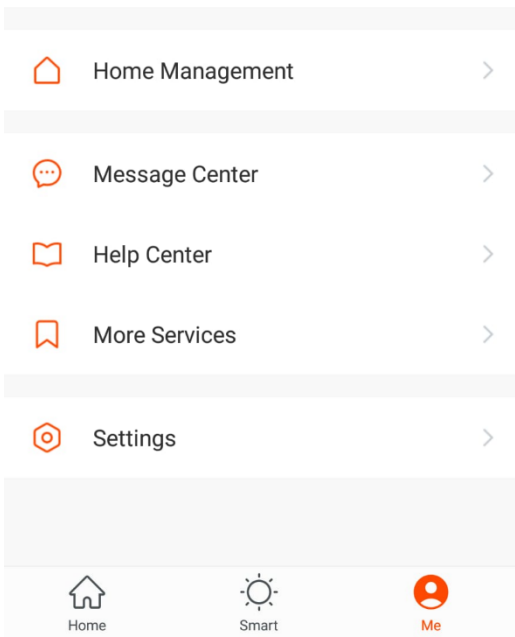

### HOME MANAGEMENT

Home Management provides options for managing your TUYA account, giving options such as adding a home, adding and removing rooms, and sharing devices with family.

### MESSAGE CENTRE

View notifications from devices, if alarms are set up (dependent on device)

### HELP CENTRE

Provides assistance using the features provided within the app

### MORE SERVICES

This allows the unit to be integrated with your favorite home automation hardware such as Google Home and the Amazon Echo.

## CONNECTION TROUBLESHOOTING

1. Check whether the device is powered on and is in the correct WiFi connection mode, if not please refer to the CHANGING BETWEEN CONNECTION MODES section.
2. Ensure the WiFi password has been entered into the app correctly (Case sensitive)
3. Check that the phone is connected to the WiFi you are connecting the device to.
4. Ensure the network you are connecting it to is 2.4Ghz (5Ghz WiFi networks are not supported), and that there is a strong WiFi signal to the item.
5. If your router is dual band, ensure that the 2.4ghz network has a different network name (SSID). Further advice on changing router settings will be available from your Internet service provider / Router manufacturer.
6. Check the settings on the router. Encryption should be WPA2-PSK and authorisation type should be set to AES
7. Try using the alternative connection method. i.e. If connection is failing when attempting to connect through CF mode, try AP mode.

## CLEANING AND MAINTENANCE

**ATTENTION:** Please shut off the unit and unplug from the mains before cleaning or performing any maintenance.

### CLEANING THE SURFACE

- Clean the heater with a duster or a soft wet cloth.  
Do not use chemical solvents (such as benzene, alcohol or gasoline) as they may cause irreversible damage. Make sure no water enters the control panel or gaps in the casing.
- Do not run the unit until completely dry.
- Place the heater in its original box or cover to protect it from dust when not in use.
- Store it in a cool dry place.

### TROUBLESHOOTING

Do not repair or disassemble the unit by yourself, unauthorized repair attempts will invalidate the warranty and may cause bodily harm.

| <b>Issue</b>                | <b>Possible Reason</b>  | <b>Solution</b>   |
|-----------------------------|---|---|
| No power                    | 1. Power cord is unconnected<br>2. There is no power from socket<br>3. The power switch on the rear of the unit is turned off.      | 1. Connect the power cord<br>2. Check socket is turned on<br>3. Ensure the power switch on the rear of the unit is in the on position               |
| Odour emission from unit    | 1. New unit. When the unit is used for the first time the fan motor may produce and odour which will dissipate within a week of use | 1. No action required   |
| Strong vibrations and noise | 1. Unit is not placed on a flat surface<br>2. Unit may be damaged   | 1. Place on a flat surface. May put an anti-vibration mat underneath<br>2. If the heater is damaged discontinue use and contact the service centre. |

If the above solutions do not resolve the problem please contact the service centre.

## TECHNICAL DATA

|                           |                |
|---------------------------|----------------|
| <b>Model no.</b>          | ECFIRPH7W      |
| <b>Voltage</b>            | 220V-240V 700W |
| <b>Frequency</b>          | 50 / 60 Hz     |
| <b>Max power</b>          | 700W           |
| <b>IP Rating</b>          | IP20           |
| <b>Product Dimensions</b> | 60x115 mm      |

## electriQ UK SUPPORT

[www.electriQ.co.uk/support](http://www.electriQ.co.uk/support)

Please, for your own convenience, make these simple checks before calling the service line.

If the unit still fails to operate call: 0330 390 3061 or complete the online form

1. Is the unit plugged into the mains?
2. Is the fuse OK?
3. Switch the unit off and wait three minutes to see if the issue is resolved. Restart the unit.

Office hours: 9AM - 5PM Monday to Friday

[www.electriQ.co.uk](http://www.electriQ.co.uk)  
Unit J6, Lowfields Business Park  
Lowfields Way, Elland  
West Yorkshire, HX5 9DA

## DECLARATION OF CONFORMITY

Hereby, electriQ declares that this heater follows Directive 2014/53/EU. The full text of the EU declaration of conformity is available at the following internet address:

<https://www.electriQ.co.uk/content/declaration-of-conformity>

Disposal: Do not dispose this product as unsorted municipal waste. Collection of such waste must be handled separately as special treatment is necessary.



Recycling facilities are now available for all customers at which you can deposit your old electrical products. Customers will be able to take any old electrical equipment to participating civic amenity sites run by their local councils. Please remember that this equipment will be further handled during the recycling process, so please be considerate when depositing your equipment. Please contact the local council for details of your local household waste recycling centres.

| Model Identifier: ECFIRPH7        |  |       |   |  |      |
|-----------------------------------|--|-------|---|--|------|
| Item                              | Symbol   | Value | Unit  | Item   | Unit |
| <b>Heat Output</b>                |  |       | <b>Type of heat input, for electric storage local space heaters only (select one)</b> |  |      |
| Nominal heat output               | $P_{nom}$  | 0.7   | kW  | manual heat charge control, with integrated thermostat                       | No   |
| Minimal heat output               | $P_{min}$  | 0.0   | kW  | manual heat charge control with room and/or outdoor temperature feedback     | No   |
| Maximum continuous heat output    | $P_{max}$  | 0.7   | kW  | electronic heat charge control with room and/or outdoor temperature feedback | No   |
| Auxiliary electricity consumption |  |       | fan assisted heat output  |  | No   |
| At nominal heat output            | $e_{l_{max}}$  | N/A   | kW  | <b>Type of heat output/room temperature control (select one)</b>             |      |
| At minimum heat output            | $e_{l_{min}}$  | N/A   | kW  | single stage heat output and no room temperature control                     | No   |
| In standby mode                   | $e_{l_{SB}}$   | 1     | W   | two or more manual stages, no room temperature control                       | No   |
|                                   |  |       |   | with mechanical thermostat room temperature control                          | No   |
|                                   |  |       |   | with electronic room temperature control                                     | No   |
|                                   |  |       |   | with electronic room temperature control plus day timer                      | No   |
|                                   |  |       |   | with electronic room temperature control plus week timer                     | Yes  |
|                                   |  |       |   | <b>Other control options (multiple selections possible)</b>                  |      |
|                                   |  |       |   | room temperature control with presence detection                             | No   |
|                                   |  |       |   | room temperature control, with open window detection                         | Yes  |
|                                   |  |       |   | with distance control option   | No   |
|                                   |  |       |   | with adaptive start control  | No   |
|                                   |  |       |   | with working time limitation   | No   |
|                                   |  |       |   | with black bulb sensor   | No   |
| Contact Details                   | electriQ, Unit J6, Lowfields Business Park, Lowfields Way, Elland, West Yorkshire, HX5 9DA |       |   |  |      |